

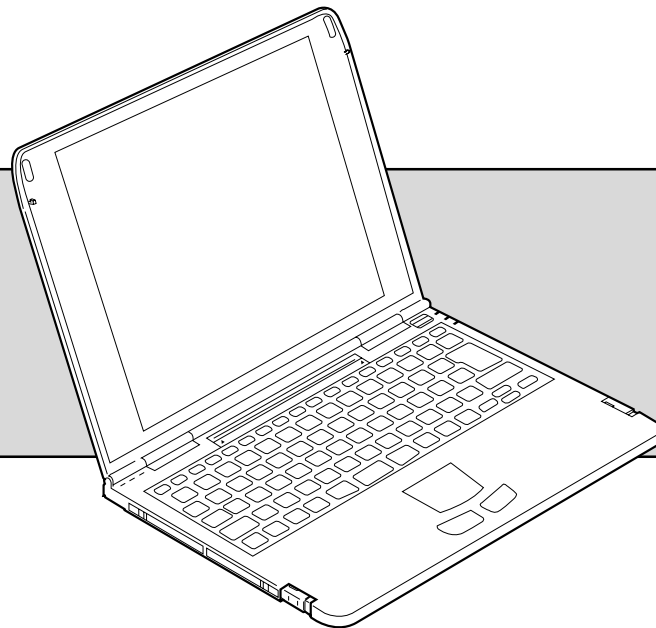

Pedion

Owner's Handbook



Certificate No.'s:
FM 1716 FS 21715 FS 30305

including
Quick Start
Guide

MITSUBISHI PEDION QUICK START GUIDE

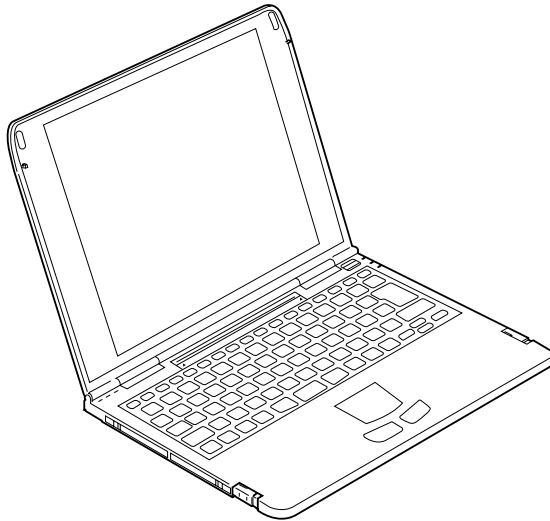

This Quick Start Guide gives you the minimum amount of information needed to start working with your new Pedion.

More detailed information is provided in the Owner's Handbook (the second part of this book).

Throughout this book "Windows" means Microsoft Windows 95. If Windows 98 or Windows NT is installed on your Pedion, certain procedural details may change. Consult your Windows documentation (manual or help files) for assistance.

For your own safety

Read through the Safety & Regulatory Notices section at the start of this manual before using the computer for the first time.

Connecting to the AC power supply

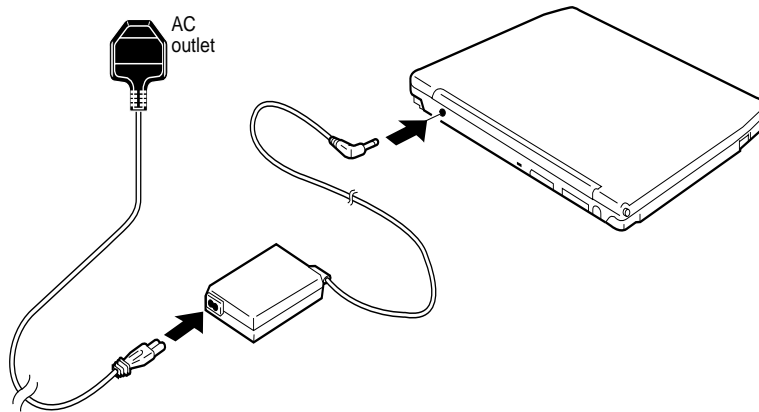

Begin by connecting the Pedion to the AC power supply. This is necessary because the Pedion's internal battery is initially uncharged.

1. Connect the AC adapter to the DC-IN connector on the rear of the Pedion.
2. Connect the power cord to the AC adapter, and plug the power cord into a nearby AC outlet.

Warning

Use only the AC adapter that comes with your Pedion. Do not attempt to use an adapter from any other equipment.

Caution

Use only with a 120-240 volt AC power supply.

Place both the computer and the Pedion on a stable surface (e.g. desktop or floor). If the AC adapter becomes detached from the system because, for example, the adapter falls off of a desktop, the power will be cut off, which may cause data loss.

Charging the internal battery

The Pedion's internal battery begins to charge as soon as you connect the Pedion to the AC power supply.

We recommend that you let the battery fully charge before using the Pedion for the first time. This should take about 3 hours. (If you use the Pedion while the battery is charging, it could take up to 12 hours.)

A fully charged battery should enable the computer to be used without an AC power supply for about 1.8 hours.

The Pedion's Battery Status light (the middle of three lights on the right-hand side) is orange while the battery is charging, green when it is charged.

A new battery may run down relatively quickly. This is quite normal. If you fully recharge the battery each time it runs down, it will soon achieve its optimum performance.

For more information, see the chapter on “Battery and Power Management” in the Owner’s Handbook.

Note

The batteries in the optional Battery Pack are also initially uncharged. If the Battery Pack is attached to the Pedion, both the Battery Pack and the Pedion's internal battery can be recharged at the same time.

Attaching the Multimedia Pack

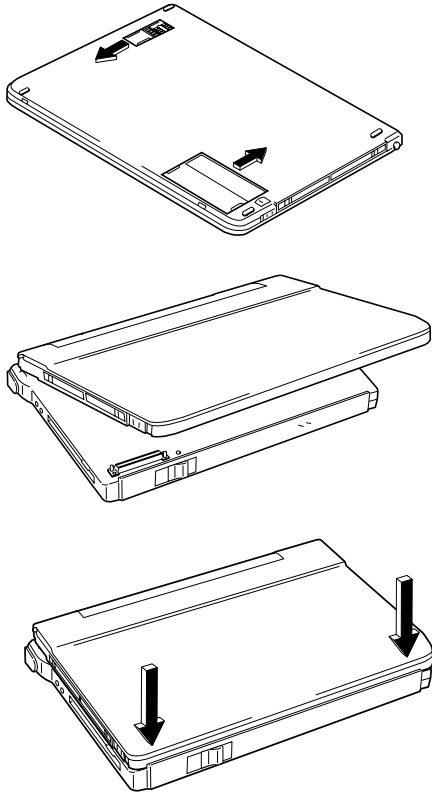

Once the Pediton's battery has been fully charged, you can connect the Multimedia Pack.

1. Ensure the Pediton is turned off.
2. Close the LCD panel and turn the Pediton over.
3. Slide open the battery and multimedia connector covers on the underside of the Pediton.
4. Align the two small holes on the rear of the Pediton with the two raised catches on the rear edge of the Multimedia Pack.
5. Gently press down on the front edge of the Pediton until it clicks into place. Do not use excessive force.

For more information, see the “Welcome” chapter in the Owner's Handbook.

Starting the Pedion

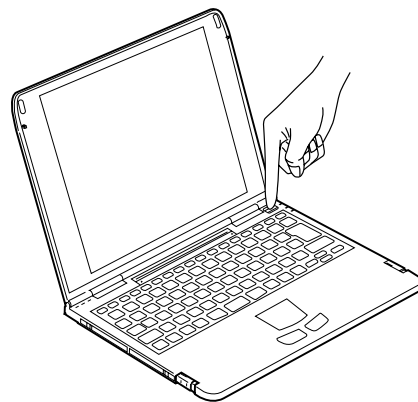
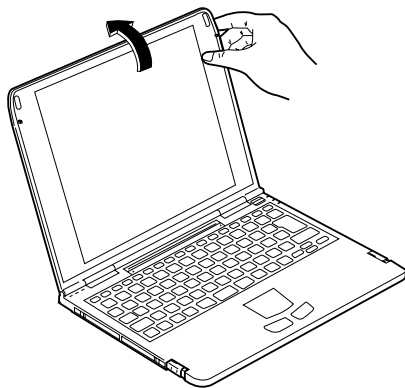
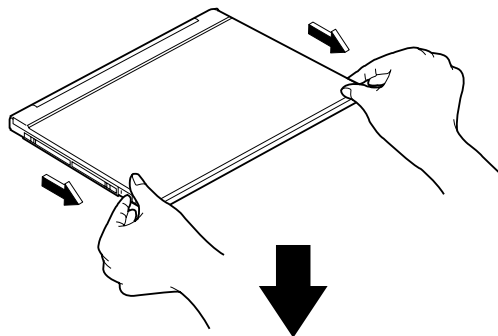

To start the Pedion

1. Slide the latches on the sides of the Pedion forward to release the LCD panel, then open it.
2. Adjust the angle of the LCD panel until you can view the display comfortably.
3. Press the Power button. The Power Status light turns green and Windows starts.

Using the touchpad

The touchpad consists of a touch-sensitive tablet and two buttons, which together perform the same function as a mouse. The left and right touchpad buttons correspond to left and right mouse buttons.

For more information, see the chapter on “Touchpad and Keyboard” in the Owner’s Handbook.

Be careful!

Don’t use the touchpad if your fingers are wet.

Don’t press too hard on the tablet’s surface. You could break it or hurt yourself.

To move the cursor

- ◆ Slide your fingertip over the surface of the tablet. To move the cursor a large distance, move your finger in the required direction several times in succession. Only slight movement is needed for more accurate positioning of the cursor.

To left-click

- ◆ Tap once with your finger tip.

To double-left-click

- ◆ Tap twice with your finger tip.

To click-and-drag

- ◆ Tap twice, but hold your finger on the tablet’s surface on the second tap, then slide your finger tip across the tablet’s surface.

OR

- ◆ Press and hold down the left touchpad button, then slide your finger tip across the tablet’s surface

Registering and configuring Windows

Registering Windows

Your computer has the Microsoft Windows operating system already in place or *pre-installed*, so that it is ready for you to set up when you turn the computer on.

The first time you start the Pedion you must tell Windows your name (and the name of the company for which you work, if applicable) and agree to the legal terms and conditions of the Windows Licence Agreement.

Windows then spends a few minutes analysing your computer and configuring itself to take full advantage of your computer's components. It also gives you the opportunity to install a printer. However, you do not have to install a printer at this time if you don't want to.

You only register once

All of this only happens the first time you turn on your computer. After that Windows starts normally, except that you may be reminded if you haven't made any back-up diskettes yet.

Increasing the resolution and colours displayed by the LCD panel

At first, Windows is configured for a display setting of 800 by 600 pixels in High Colour (16 bit).

The Pedion's LCD panel can do better than this setting. You should therefore change the display setting to get the best performance from your system.

1. Move the cursor into an unoccupied area of the Windows desktop and press the right touchpad button, then select **Properties** from the pop-up menu.
2. Click the Settings tab of the Display Properties dialog.
3. You can now select the Desktop Area (resolution) and Colour Palette (number of colours). We suggest 800 by 600 pixels in True Colour (24 bit).

Conserving battery power

Tips on conserving battery power

- ◆ Whenever possible, work with the AC adaptor connected and plugged in to the supply. That way, the Pedion's internal battery recharges while you work.
- ◆ To pause briefly when working, close the LCD panel. This puts the Pedion to sleep (Memory Suspend mode). To resume working, open the LCD panel and press the Power button.
- ◆ For more lengthy interruptions in your work, press the Power button and wait for everything to be saved to disk (Disk Suspend mode). To resume working, press the Power button again.
- ◆ When you've finished work, shut down Windows in the normal way. This automatically turns off the Pedion.

For more information, see the chapter on "Battery and Power Management" in the Owner's Handbook.

How long can I work on battery power?

Internal battery only

Lasts for up to	1.8 hours
Recharge (while working)	12.0 hours
Recharge (while turned off)	3.0 hours

Internal battery plus optional Battery Pack

Lasts for up to	7.2 hours
Recharge via Pedion (while working)	30.0 hours
Recharge via Pedion (while turned off)	8.0 hours
Recharge directly via AC adaptor	8.0 hours

These times depend on the programs you are running and how much use you make of the hard disk and CD-ROM drive.

Shutting down the Pedion

Normal shutdown

To shut down the Pedion safely:

1. Wait until all the activity indicators on the Pedion and Multimedia Pack show 'not busy'.
2. Remove any diskettes and CDs from the Multimedia Pack.
3. Turn off any attached peripherals.
4. Click the **Start** button in the Windows task bar, then click **Shutdown**.
5. Select **Shut down the computer** and click **Yes**.

Windows shuts down. The Power Status light goes out.

Emergency shutdown

In exceptional circumstances you can insert the tip of a pencil (or similar non-metallic object) into the Emergency OFF hole below the left side of the keyboard. This turns off the Pedion without shutting down Windows first. Any unsaved work will be lost.

Use the emergency shutdown procedure only if the Pedion stops responding, and pressing **Ctrl + Alt + Del** doesn't restart Windows.

Make sure it is an emergency!

In an emergency shutdown, you may lose any recent changes made to the files you are working on. The Microsoft ScanDisk program will run automatically when the computer next starts, to check for disk errors.

Where to get more information

There are various help files available on the computer. In particular, you should use **Windows Help**, which can be accessed from the **Start** menu, to help with Windows-related problems. We also recommend that you double-click the **Important Apricot User Information** icon on the Windows desktop for late-breaking information relating to your computer.

MITSUBISHI PEDION OWNER'S HANDBOOK

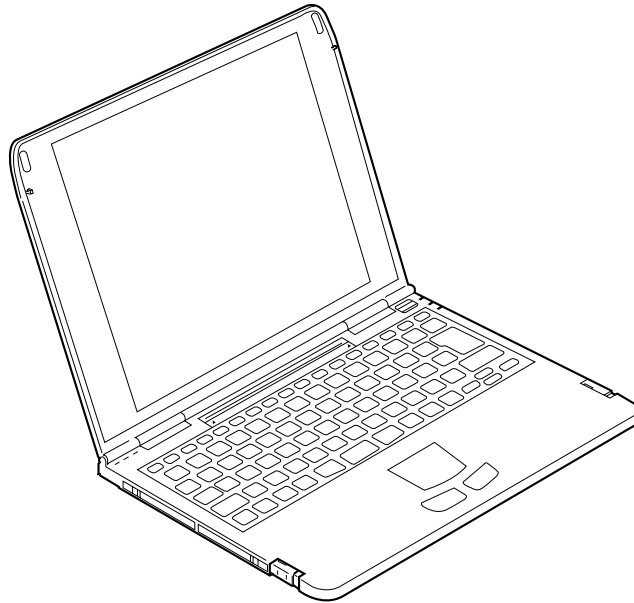

Intel®, Pentium® and Pentium® II are registered trademarks, and MMX™ is a trademark, of Intel Corporation. Pedion™ is a trademark of Mitsubishi Electric Corporation. IrDA® is a registered trademark of the Infrared Data Association. Microsoft, MS-DOS, and Windows® are registered trademarks of Microsoft Corporation in the US and other countries. JEIDA® is a registered trademark of the Japan Electric Industry Development Association. PCMCIA® is a registered trademark of the Personal Computer Memory Card International Association. Sound Blaster Pro® is a registered trademark of Creative Labs Incorporated, a subsidiary of Creative Technologies Limited.

Other trademarks mentioned within this document and not listed above are the properties of their respective owners.

Information contained in this document is subject to change without notice and does not represent a commitment on the part of Apricot Computers Limited. Any software described in this manual is furnished under a license agreement. The software may be used or copied only in accordance with the terms of this agreement. It is against the law to copy any disk supplied for any purpose other than the purchaser's personal use.

No part of this manual may be reproduced or transmitted in any form or by any means electronic or mechanical including photocopying and recording, for any purpose, without the express written permission of the publishers.

Copyright © Apricot Computers Limited 1998. All rights reserved.

Published by:
Apricot Computers Limited
3500 Parkside
Birmingham Business Park
Birmingham, England
B37 7YS

<http://www.mitsubishi-computers.com>



Printed in the United Kingdom

SAFETY AND REGULATORY NOTICES

General

Electrical safety

The system uses a safety ground and must be earthed.

The AC adapter and power cord is a 'disconnect device'. Ensure that the AC adapter is positioned close to the AC power outlet and that the plug is easily accessible.

The AC adapter and power cord packed with the computer comply with the safety standards applicable in the country in which it is first sold. Use only this AC adapter and power cord. Do not substitute an AC adapter or power cord from any other equipment. Do not use the AC adapter with any other equipment.

Do not short-circuit the terminals of the AC adapter.

Do not attempt to disassemble the computer, its accessories or the AC adapter. If a fault occurs, contact your Mitsubishi Electric PC supplier or maintainer.

To prevent fire and electric shock, do not expose the computer, its accessories or the AC adapter to rain or moisture. Do not use the AC adapter outdoors.

Do not let metal or other conductive items (for example, paperclips) drop into the computer via either a port or a connector opening.

Avoid forcibly bending, pulling or twisting cables. Unplug the power cord by grasping the plug, not the cord. Avoid treading on or putting any weight on the power cord. Unplug the AC adapter when not in use.

Do not attempt to remove the computer's internal battery or dispose of it by incineration.

Do not touch the naked connectors of either the computer or its accessories. Doing so can result in an electric shock or a damaging electrostatic discharge.

Do not use the computer if it is producing smoke or unusual noises.

Laser and LED products

Any CD-ROM drive used in this system is classified as a CLASS 1 LASER PRODUCT according to IEC825 *Radiation Safety of Laser Products (Equipment Classification: Requirements and User's Guide)*. The CLASS 1 LASER PRODUCT label is located on the underside of the CD-ROM unit.



The CD-ROM drive contains a laser system which is harmful to the eyes if exposed. Do not attempt to disassemble the CD-ROM drive; if a fault occurs, call an authorised maintainer.

Use the CD-ROM drive only as described in this manual. Failure to do so may result in exposure to hazardous radiation.

This computer is a CLASS 1 LED PRODUCT. To avoid eye injury, do not stare into the infrared transceiver lens when it is in use.

Liquid Crystal Display

Do not attempt to disassemble the LCD panel. If damage to the LCD panel allows some of the liquid crystal to leak out, do not ingest any of the liquid or breath its vapour.

If you do ingest liquid crystal, immediately rinse out your mouth with water. If liquid crystal gets in your eyes, immediately douse your eyes with water for at least 15 minutes, then seek urgent medical attention. If liquid crystal gets onto your skin or clothing, immediately wash it off with soap and water.

Ergonomics

Avoid using the computer when placed directly on your lap for long periods; it can generate enough heat to cause low-temperature burns.

Do not use the touchpad if your fingers are wet. Do not press too hard on the touchpad's surface; you could break it or hurt yourself

Do not attempt to use a CD music player program while a data CD-ROM is in the drive. This may damage your ears or the computer's speakers.

When positioning the system, take into account any local or national regulations relating to ergonomic requirements.

Anti-static precautions

Warning

Static electricity can cause permanent damage to electronic components. You should be aware of this risk, and take precautions against the discharge of static electricity into the computer.

The computer is at risk from static discharge while the connector covers on the underside are open. This is because the electronic components are exposed.

Ideally, the connector covers should be opened only in an area completely free of static electricity. It is also a good idea to use an ionizer or humidifier to remove static from the air.

Do not open the connector covers until you need to. Do not touch the exposed connectors.

Keep all conductive material, and food and drink, away from your work area and the open connectors.

Maintenance

Switch off and disconnect all cables before attempting to clean the computer.

Do not use sprays, solvents or abrasives that might damage the computer's surface. Do not use cleaning fluids or sprays near air vents, ports, or the diskette and CD-ROM drives.

Occasionally clean the diskette and CD-ROM drives using a proprietary head cleaner.

Transporting

Always handle the computer gently. Take care not to drop or knock the computer, its accessories, or the AC adapter.

If you are planning to use the computer in another country, check first with your Mitsubishi Electric supplier to ensure the availability of the correct AC power cords and/or AC adapter.

Note

Any existing maintenance or warranty agreement may not be supportable in another country. The system may have to be returned to the supplier.

Standards

Safety

This product complies with the European safety standard **EN60950** which will, when applicable, include the national deviations for the country in which it is sold.

Electro-magnetic Compatibility (EMC)

This product complies with the following European EMC standards:

Emissions	EN50022 Class B
Immunity	EN50082

Notes

All interconnecting cables (for example, signal and communication cables) should be less than 2 metres in length. If cable extensions are used, ensure adequate earth connections are provided and screened cables are used.

If any metal casework components are removed, during upgrade work for example, ensure that

all metal parts are correctly re-assembled and all internal and external screws are re-fitted and correctly tightened.

Legalities

This equipment complies with the relevant clauses of the following European Directives (and all subsequent amendments):

Low Voltage Directive	73/23/EEC
EMC Directive	89/336/EEC
CE Marking Directive	93/68/EEC

Important

This system complies with the CE Marking Directive and its strict legal requirements. Use only parts tested and approved by Mitsubishi Electric PC Division. Failure to do so may result in invalidating both the compliance and your warranty. All expansion cards, drives and peripherals must carry the CE mark to ensure continued compliance.

Power Connection

Typical AC plugs

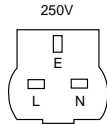
**BS1363A**

U. K.

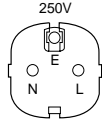
**SHUCO**

Austria Belgium
 Finland France
 Italy Germany
 Sweden Norway
 Holland

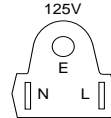
**NEMA 5-15P**

Taiwan
 Thailand
 Japan
 USA
 Canada

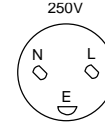
**SRAF 1962/DB16/87**

Denmark

**ASE 1011**

Switzerland

Checking the AC power supply

When this product is delivered, it is ready for the commercial AC power supply generally available in the country in which it is first sold. It is supplied with an AC power cord and plug which comply with the relevant safety standards.

Before using the product in a country other than that in which it was originally sold, you must check the voltage and frequency of that country's AC power supply, and the type of power cord required there. Check the power rating labels on the underside of the computer to ensure that they are compatible with the AC power supply.

Connecting to the AC power supply

Important

Any peripheral equipment that requires an AC power cord must be earthed.

Use the following guidance to connect the components together. It is important that you take each step in the order indicated.

1. Before connecting any components, ensure that the AC power supply is switched off or disconnected, and that the computer, and any peripherals are turned off.
2. Connect the AC adapter to the DC-IN connector on the rear of the computer.
3. Connect the power cord to the AC adaptor.
4. Plug the computer's power cord, and the power cords of any other peripherals, into nearby, grounded AC power outlets. Switch on or connect the AC power supply.
5. Turn on any peripherals first, then the computer.

Power Cable Connections - UK ONLY

This product is supplied with an AC power cord that has a non-removable moulded plug.

Always replace the fuse with one of the same type and rating which is BSI or ASTA approved to BS1362. Always refit the fuse cover, never use the plug with the fuse cover omitted.

CONTENTS

1 Welcome

Pictorial guide to the Pedion	1/2
Pictorial guide to the Multimedia Pack.....	1/5
Backing up the pre-installed software	1/8
General advice	1/9

2 Touchpad and Keyboard

Using the touchpad	2/1
Using the keyboard.....	2/3

3 Diskette, CD-ROM and Audio

Using the diskette (floppy disk) drive	3/1
Using the CD-ROM drive	3/3
Using the audio features	3/5

4 Battery and Power Management

Using battery power	4/1
Options for power management.....	4/6
More about Disk Suspend mode	4/8
More about Memory Suspend mode	4/10

5 Connecting Optional Devices

Installing a PC Card.....	5/2
Connecting an infrared device	5/4
Connecting a USB device.....	5/8
Connecting a printer (parallel port device)	5/9
Connecting a serial port device.....	5/10
Connecting an external keyboard or mouse.....	5/11
Connecting an external monitor.....	5/12

6 BIOS Setup

Using the Setup utility..... 6/1

The most useful options within Setup 6/5

7 Troubleshooting

Pedion..... 7/2

Diskette drive (FDD) 7/2

Hard disk drive (HDD)..... 7/3

CD-ROM 7/3

Internal battery or Battery Pack..... 7/4

LCD panel 7/4

Serial port device 7/5

PC Cards..... 7/5

External keyboard, numeric keypad or mouse..... 7/6

Printer 7/7

Touchpad..... 7/7

External monitor 7/8

Infrared communication..... 7/9

Microphones, headphones and audio 7/10

USB device..... 7/10

Appendix

1 WELCOME

This first chapter gives you a quick tour of your new Mitsubishi Pедion mobile computer. It lists the special features of the computer and has pictorial guides to help you identify the various parts.

If you want to get started working with your Pедion straight away, follow the instructions given in the Quick Start Guide at the front of this manual.

Use the page at the end of this manual to make a note of the manufacturer's data recorded on the various components (product codes, serial numbers, etc.). A service engineer may need this information if the computer develops a fault.

For your own safety





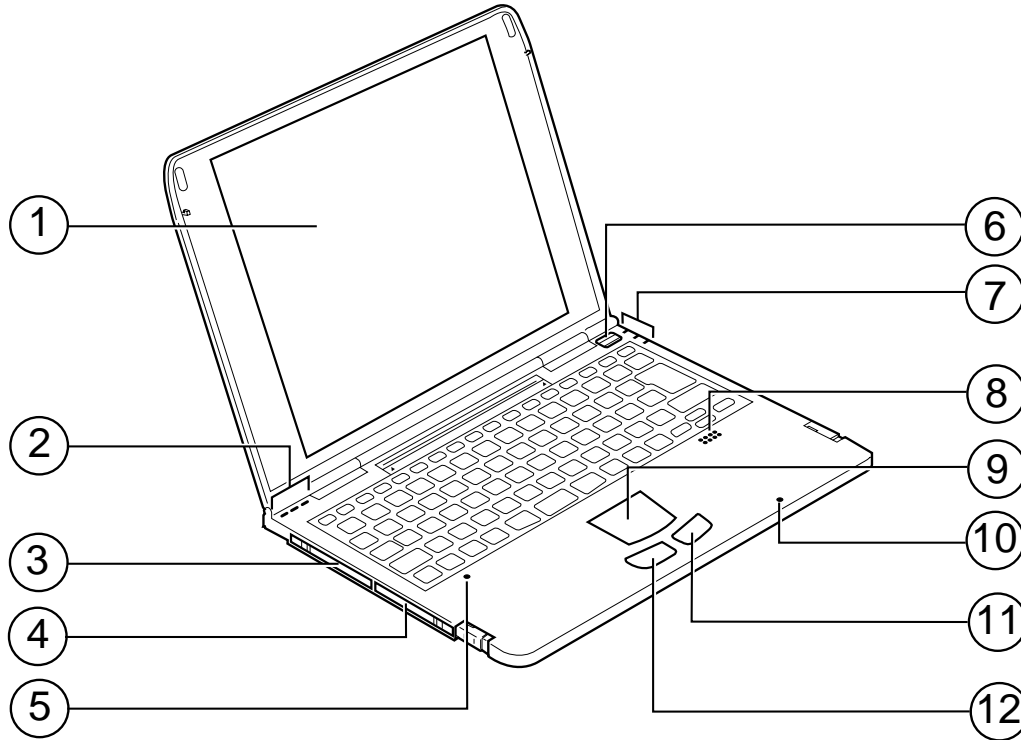

Read the Safety & Regulatory Notices section at the start of this manual before using the computer for the first time.

Features

- ◆ 18 mm thick with the LCD panel closed. Weighs 1.5 kg.
- ◆ 233 MHz Mobile Pentium processor with MMX technology. 12.1" TFT display, 2 GB hard disk, 64 MB EDO memory.
- ◆ Multimedia Pack (docking station) with CD-ROM, diskette drive and peripheral ports.
- ◆ Two Type I/II PC Card slots (PCMCIA 2.1/JEIDA 4.2). Zoomed Video (ZV) and CardBus support. IrDA 1.1 FIR infrared port.
- ◆ Universal Serial Bus port (with a second USB port on the Multimedia Pack).
- ◆ Sound Blaster Pro compatible 16-bit audio system.
- ◆ 1.8 hours battery life extendible to 7.2 hours with optional Battery Pack.

Pictorial guide to the Pedion



- 1 LCD panel
- 2  Num Lock light
 Caps Lock light
 Scroll Lock light
- 3 PC Card Slot 0 (CardBus/Zoomed Video)
- 4 PC Card Slot 1 (CardBus)
- 5 Emergency OFF hole (if the Pedion stalls, insert a non-metallic probe such as a pencil tip)
- 6 Power button
- 7  Power Status light
 Battery Status light
 Hard disk activity light
- 8 Speaker (mono)
- 9 Touchpad
- 10 Microphone (mono)
- 11 Right touchpad button
- 12 Left touchpad button

The Power button alternately turns on the Pedion and puts it into Disk Suspend mode.

The  Power Status light is green when the Pedion is working normally, orange in Memory Suspend mode, and unlit when the Pedion is shut down or in Disk Suspend mode.

The  Battery Status light is green when the internal battery is fully charged, orange when it is recharging, and unlit when the Pedion is running on battery power.

For more information about the Pedion's power-saving modes, see the chapter on "Battery & Power Management".

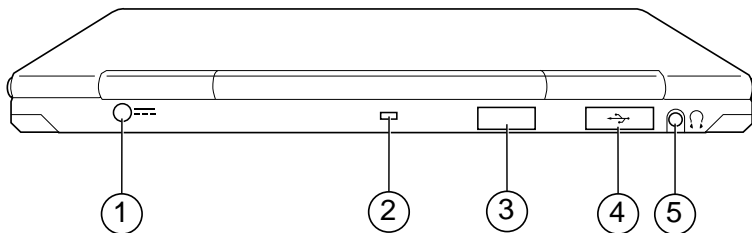

- 1 DC-IN connector (for AC adapter)
- 2 Security notch (for attaching an anti-theft chain)
- 3 Infrared communication port
- 4 USB port (behind protective rubber cover)
- 5 Audio output jack (stereo)

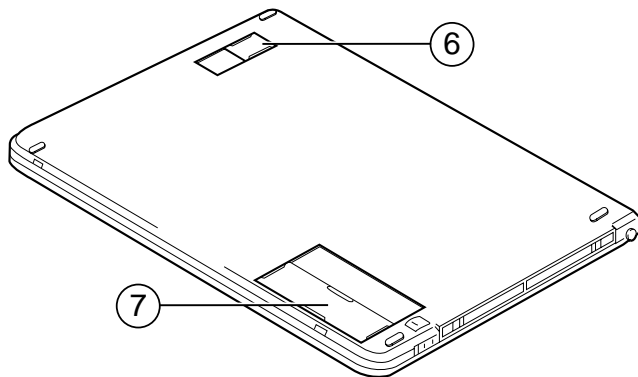

Pictorial guide to the Multimedia Pack

By attaching the Multimedia Pack to your Pedion, you can use diskettes and CD-ROMs, and connect various peripheral devices.

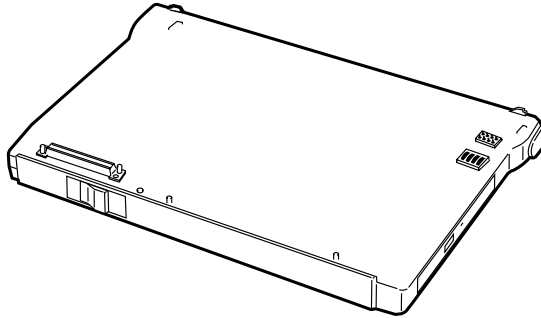

Caution

Do not open the battery connector cover on the underside of the Pedion unless you intend to install either the Multimedia Pack (or the Battery Pack) straight away.

Note

You must shut down the Pedion before attaching or removing the Multimedia Pack.

OWNER'S HANDBOOK

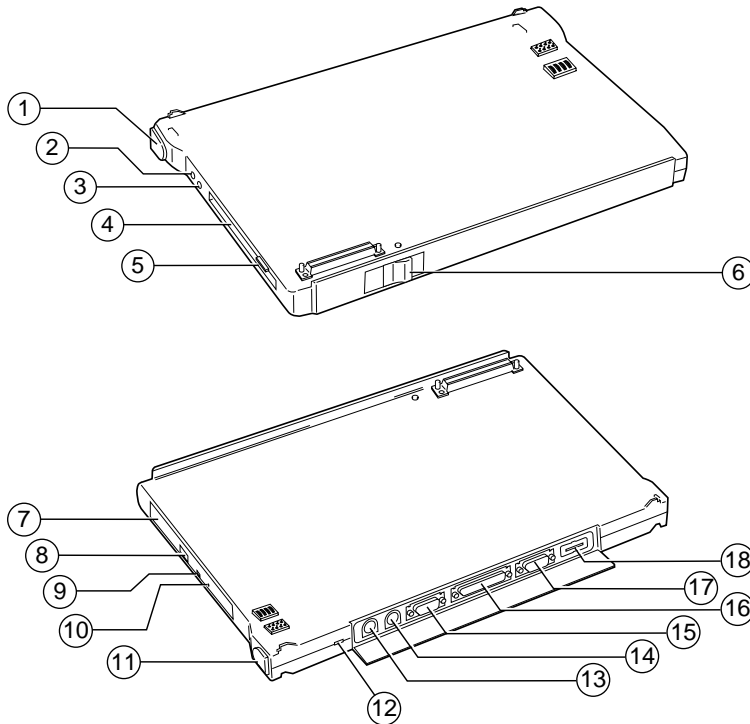

- 1 Stereo speaker (left)
- 2 Line/microphone input jack
- 3 Audio output jack (stereo)
- 4 Diskette (floppy disk) drive
- 5 Diskette eject button
- 6 Pedion release lever
- 7 CD tray
- 8 CD eject button
- 9 CD activity light
- 10 CD emergency eject hole
- 11 Stereo speaker (right)
- 12 Security notch (for attaching an anti-theft chain)
- 13 Keyboard port
- 14 Mouse port
- 15 Serial port
- 16 Parallel port
- 17 Monitor port
- 18 USB port

To attach the Multimedia Pack

1. Shut down the Pedion.
2. Close the LCD panel and turn the Pedion over.
3. Slide open the battery and multimedia connector covers on the underside of the Pedion.

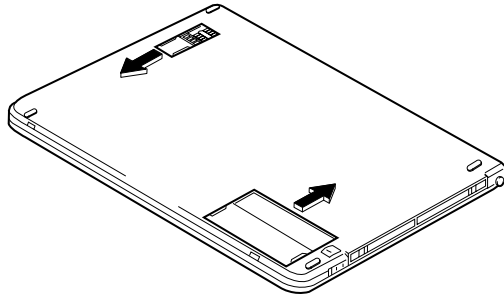

4. Align the two small holes on the rear of the Pedion with the two raised catches on the rear edge of the Multimedia Pack.

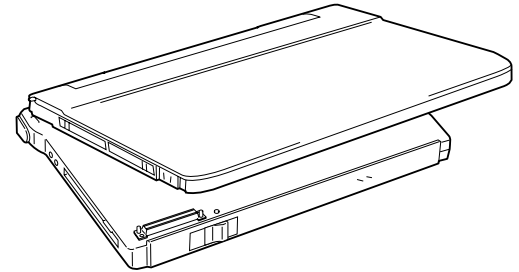

5. Gently press down on the front edge of the Pedion until it clicks into place. Do not use excessive force.

To remove the Multimedia Pack

1. Remove any CD or diskette from the drives.
2. Shut down the Pedion.
3. Close the LCD panel.
4. Slide the lever on the front of the Multimedia Pack to the left, then lift the Pedion off the Multimedia Pack (front edge first).
5. Turn the Pedion over and close the multimedia and battery connector covers on the underside.

Backing up the pre-installed software

Creating an emergency startup disk

We *strongly* recommend that you create an emergency startup disk. This will enable you to start Windows in the event of your existing Windows software becoming corrupted.

1. On the **Start** menu, point at **Settings**, then click **Control Panel**.
2. In the Control Panel, double click the **Add/Remove Programs** icon.
3. On the Startup Disk tab of the Add/Remove Programs Properties dialog, click **Create Disk**.
4. Insert a formatted, 1.44 Mbyte diskette into the diskette drive. Follow the on-screen instructions.

Backing up your system

We also recommend that you copy or 'back-up' Windows and any other pre-installed software soon after setting up the system. This is particularly important for systems supplied without installation disks for the software on the hard disk. A back-up

copy will safeguard the pre-installed software against loss if the hard disk fails or if you accidentally overwrite or delete files.

- ◆ The Microsoft Create System Disks utility allows you to create installation diskettes from disk images pre-installed on the hard disk.
- ◆ To back up other pre-installed software (and your own files) use the Backup tool. Click the **Start** button in the Windows taskbar, then **Programs, Accessories, System Tools and Backup**.

In general, any copy you make of pre-installed software must be used only as a back-up copy, in case the pre-installed version is lost. You are **not** allowed to use installation diskettes created from disk images to install the software onto another computer.

General advice

As a portable computer, this machine is designed to be used in various environments. The following paragraphs contain guidelines in caring for yourself and your computer.

- ◆ Place the computer on a firm, level surface if possible, away from vibration.
 - ◆ Use the computer away from moisture, direct sunlight, and extremes of heat and cold. Avoid situations in which the surrounding temperature or humidity may change rapidly. When the computer is in use, the temperature should be between 10 and 35°C and humidity between 20% and 80% (with no condensation).
 - ◆ In winter, moving the computer from outdoors to the warm indoors can cause moisture to condense inside the system. Allow time for the computer to dry out before turning it on.
 - ◆ Make sure there is adequate space around the computer for ventilation.
 - ◆ Always handle the computer gently.
- ◆ Ensure that you maintain a healthy posture when using the computer. Ideally, your feet should be on the floor and your legs at right angles, with your upper legs approximately horizontal. Your back should be kept straight, and your elbows should be about the same height as the keyboard. Also, your eyes should generally be approximately 0.5m from the display, with the top of the screen as close to your direct line of vision as possible.

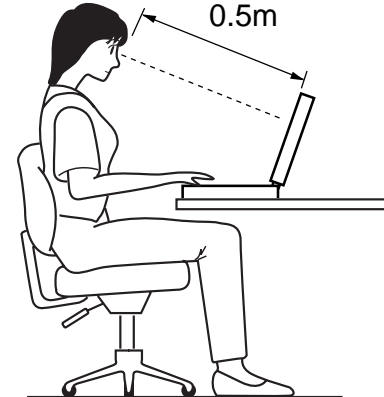

- ◆ Avoid using the computer when placed directly on your lap for long periods. It can generate enough heat to cause low-temperature burns. (redness or blisters)
- ◆ When positioning the computer, take into account any local or national regulations relating to ergonomic requirements. For example, you should ensure that little or no light is reflected off the screen as glare, and that the keyboard is placed in a comfortable position for typing.
- ◆ You should be aware that in some places, the use of a portable computer is strictly forbidden. For example, you should check before using your portable computer inside a hospital, or before boarding an aircraft.
- ◆ Make sure that any sensitive information on your computer is protected by using access passwords.
- ◆ Keep the computer away from strong magnetic fields, such as stereo speakers.
- ◆ Do not use the computer near liquids or corrosive chemicals
- ◆ Ensure all cables, particularly power cords, do not trail across the floor where people walking past can snag them.
- ◆ Keep the computer unit clean, using a non-abrasive cloth.

2 TOUCHPAD & KEYBOARD

Using the touchpad

The touchpad consists of a touch-sensitive tablet and two buttons, which together perform the same function as a mouse. The left and right touchpad buttons correspond to left and right mouse buttons.

How to use the touchpad

- ◆ Touch the tablet only with your finger tip. Don't use your fingernails or a pen, or wear a glove.
- ◆ Touch only one place on the tablet's surface. Touching two or more places at the same time confuses the software.
- ◆ Tapping the tablet's surface acts like clicking a left mouse button.

Caution

Don't use the touchpad if your fingers are wet. Don't press too hard on the tablet's surface; you could break it or hurt yourself.

Touchpad gestures

The basic touchpad gestures are as follows

- ◆ **To move the cursor:** Slide your finger tip across the surface of the tablet. To move the cursor a large distance, move your finger in the required direction several times in succession. Only slight movement is needed for more accurate positioning of the cursor.
- ◆ **To left-click:** Tap once with your finger tip.
- ◆ **To double-left-click:** Tap twice with your finger tip.
- ◆ **To click-and-drag:** Tap twice, but hold your finger on the tablet's surface on the second tap, then slide your finger tip across the tablet's surface.

Mouse Properties

Double-click the Touchpad icon in the Windows taskbar to open the Mouse Properties dialog.



Touchpad icon

You can use this dialog to configure many additional features of the touchpad. For example, you can add a tapping gesture that mimics a right-click.

For more information, click the Help button in the Mouse Properties dialog.

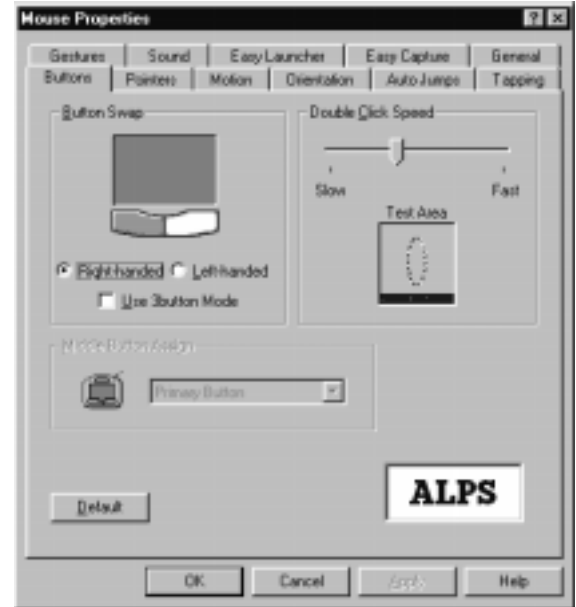

Using the keyboard

The Pedion's keyboard works just like a full-sized computer keyboard, but some keys have additional functions.

Locking keys

The keyboard has some locking keys whose status is indicated by the lights on the upper left edge of the computer.

- ◆ **Num Lock.** Press the NL/SL key to turn on numeric locking. With the Num Lock light on, the keys marked in blue on the keyboard work as a numeric keypad.
- ◆ **Caps Lock.** Press the Caps Lock key to turn on capitals locking. With the Caps Lock light on, the characters you type are displayed in uppercase.
- ◆ **Scroll Lock.** Hold down the Fn key then press the NL/SL key to turn on scroll locking. The effect usually depends on the specific software you are using.

Blue numeric keypad

When the  Num Lock light is on, you can type the numerals or symbols marked in blue.

When you press any key on the numeric keypad with the Shift key held down, the definition of that key changes to a cursor control key, as shown below.

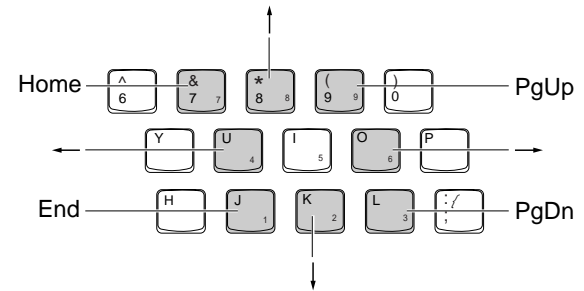



When the Num Lock light is on, pressing any key on the numeric keypad with the Fn key held down allows you to type the normal character associated with that key (that is, as if the Num Lock light were off).

Orange function keys

Some keys have additional functions, marked in orange. Hold down the Fn key while pressing the required “orange” key to access these functions.

- Fn + F2 Backslash “\” character. (Shift + Fn + F2 produces the vertical bar “|” character.)
- Fn + F9 Increases the brightness of the screen.
- Fn + F8 Decreases the brightness of the screen.
- Fn + F10 Turns audio output on and off.

Windows keys

The keyboard has two keys dedicated to Windows functions: the  Windows logo key (WIN) and the  Application key (APP).

- WIN Opens the **Start** menu.
- WIN + Tab Makes applications active in the order they are indicated on the task bar.
- WIN + E Activates Windows Explorer.
- WIN + F Starts the Find function (equivalent to **Start, Find, Files or Folders**).
- WIN + M Minimises all windows (Shift + WIN + M restores all windows).
- WIN + R Starts the Run function (equivalent to **Start, Run**).
- APP Displays a context menu (as if you had clicked the right-hand touchpad or mouse button).

3 DISKETTE, CD-ROM & AUDIO

Using the diskette (floppy disk) drive

You can use either 1.44 Mbyte (2HD) or 720 Kbyte (2DD) 3.5-inch diskettes in the Multimedia Pack's diskette drive.

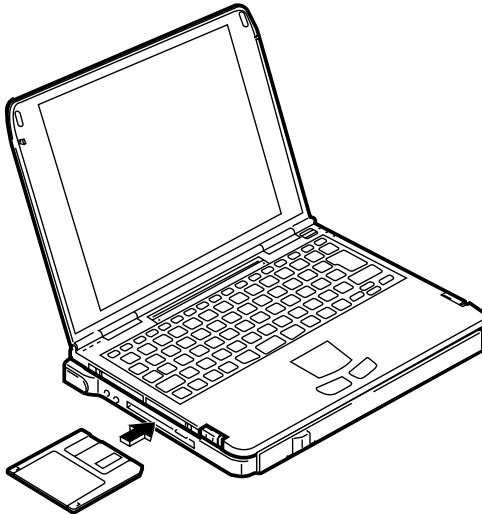

Advice on handling diskettes

- ◆ Never touch the disk surface beneath the metal shutter.
- ◆ Keep diskettes away from dust, direct sunlight, heat, moisture, high humidity, magnetic objects and electrical equipment that may generate magnetic fields.
- ◆ Write on the disk label *before* you attach it to the diskette, or use a soft felt-tip pen. Make sure the label fits within the slightly recessed area on the face of the diskette.

Note

Do not place a diskette on top of the Pedion's internal speaker. The magnetic field from the speaker can damage the data on the diskette

To insert a diskette

- ◆ Push the diskette into the drive, metal shutter foremost, and with the label side facing upwards, until it clicks into place.

To eject a diskette

1. Ensure that the diskette activity light is off.
2. Press the diskette eject button.

If a diskette becomes stuck in the drive, perhaps because its label has peeled back, do not attempt to remove it with tweezers or any similar implement; you risk damaging the drive. Call an authorised maintainer.

To write-protect a diskette

- ◆ Slide the small plastic tab on the reverse of the diskette to uncover the hole beneath it.

You can read, copy or print the files on a write-protected diskette, but you cannot create, rename or delete any files.

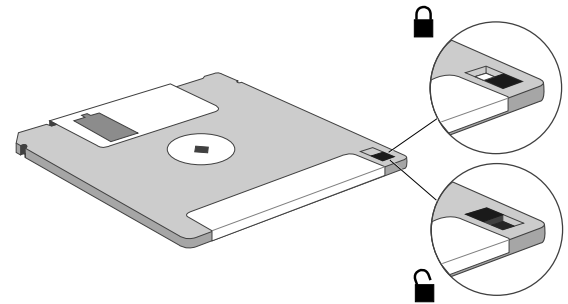

Using the CD-ROM drive

You can use either audio or data compact discs (CDs) in the Multimedia Pack's CD-ROM drive.

Advice on handling CDs

- ◆ Make sure the CD drive is empty before turning off the Pedion.
- ◆ Avoid touching the disc's surface. Hold the CD by its edges.
- ◆ Keep CDs away from direct sunlight, heat, humidity, dust and moisture.
- ◆ To clean a CD, wipe the surface *radially outwards from the centre* using a soft cloth. Do not use any cleaning agent.

Warning

The CD-ROM drive contains a laser system which is harmful to the eyes if exposed. Do not attempt to disassemble the CD-ROM drive; if a fault occurs, call an authorised maintainer.

Caution

Do not attempt to use the Windows CD player program while a data CD-ROM is in the drive. This may damage your ears or the speakers.

Note

Do not move or nudge the Pedion while a CD is in the drive, particularly while the CD activity light is on. This can damage the CD or the drive.

To load a CD

1. Turn on the Pedion.
2. Press the CD eject button. The CD tray comes out about 1.5 cm.
3. Pull the CD tray out to its fullest extent.
4. Set the CD on the CD tray, with the label side uppermost. Press down on the CD gently but firmly so that it is held securely in position.
5. Push in the CD tray until it clicks into place. The CD activity light flashes as the drive comes up to speed.

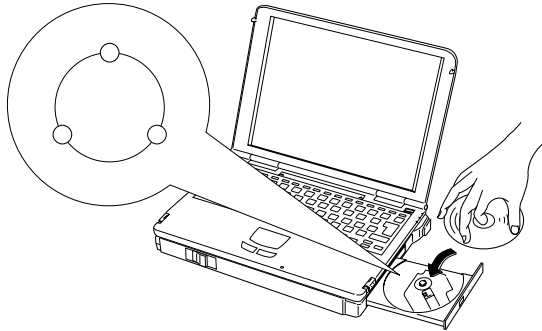

To remove a CD normally

1. Ensure that the Pedion is turned on and that the CD activity light is off.
2. Press the CD eject button.

To remove a CD when there is no power

1. Ensure that the Pedion is turned off.
2. Insert a thin non-metallic probe, such as a pencil tip, into the CD emergency eject hole. The CD tray comes out about 1.5 cm.

Using the audio features

The Pedion has a 3.5 mm stereo mini-jack for audio output, plus an internal microphone and mono speaker.

The Multimedia Pack has a line/microphone input and a stereo audio output jack, plus internal stereo speakers.

If the Pedion is docked with the Multimedia Pack, the Pedion's audio output jack and internal speaker are automatically disabled.

To extend the stereo speakers

Press gently on the left speaker to release it, then pull it out. Repeat for the right speaker.

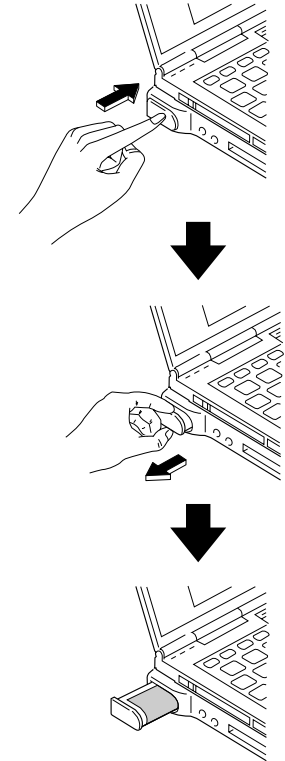

Audio input

The line/microphone input jack on the Multimedia Pack can accept input from a cassette, CD, mini-disk or DAT player, hi-fi equipment or a self-powered microphone.

When using an external self-powered microphone, you must enable the line-in input for recording and disable the (internal) microphone, as follows:

1. Double-click the Loudspeaker icon in the taskbar to open the Volume Control dialog.
2. From the **Options** menu, click **Properties**.
3. Select **Recording**, and make sure that the **Line-In** option is ticked. Click **OK**.
4. Make sure the Microphone Balance **Select** option is *not* ticked.

Audio output

The audio output jack on the Pedion or the Multimedia Pack can be used to connect cassette, mini-disk or DAT recorders, headphones, self-powered speakers, or hi-fi equipment.

When anything is attached to an output jack, the system's speakers are muted automatically.

TEAC CD Player

The TEAC CD player program is pre-installed on the Pedion's hard disk as an alternative to the Microsoft CD Player.

- ◆ Click **Start**, point at **Programs**, **Teac CD Player**, then click **CD Player 95**.

For more information, refer to the player's on-line help.

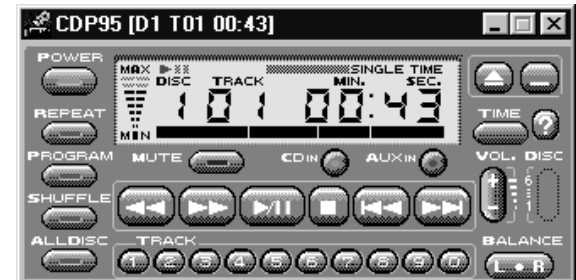

4 BATTERY & POWER MANAGEMENT

Using battery power

The Pedion can operate from its internal battery for up to 1.8 hours, depending on the programs you are running and how much use you make of the hard disk and CD-ROM drive.

An optional Battery Pack can be attached to the base of either the Pedion or the Multimedia Pack, extending the operating time to up to 7.2 hours.

You can recharge the internal battery and the Battery Pack 300 to 500 times before their performance starts to degrade. At this point you should contact your Mitsubishi Electric PC dealer or maintainer.

General advice

- ◆ At first, the internal battery is not charged. Before using your Pedion for the first time, you must charge the battery. The same applies to the optional Battery Pack.
- ◆ A new battery may be discharged in an unexpectedly short time. Fully recharge it before using it again.
- ◆ You should recharge and discharge fully each time. Partial recharges/discharges will shorten the battery's lifetime.
- ◆ Extreme temperatures (high or low) will shorten the battery's lifetime.
- ◆ Neither the Pedion's internal battery nor the batteries in the Battery Pack can be removed. If they become worn out, contact your Mitsubishi Electric PC supplier.

Recharging the internal battery

The Pedion's internal battery begins to recharge as soon as you connect the Pedion to the AC power supply.

The Pedion's Battery Status light  is orange while the battery is recharging, green when it is recharged. The time to recharge depends on the method you use:

- Recharge (while working) 12 hours
- Recharge (while turned off) 3 hours

Checking the battery level (1)

You can quickly check the battery level by positioning the cursor over the Battery Meter icon on the Windows taskbar. A "tool-tip" appears showing the amount of battery life remaining, expressed either in time or as a percentage of full charge. (The Battery Meter icon looks like a battery when the Pedion is on battery power, or like a power cord when the Pedion is connected to the AC power supply.)



Battery Meter icons

If you want more information, you can double-click the icon to open the Battery Meter dialog.

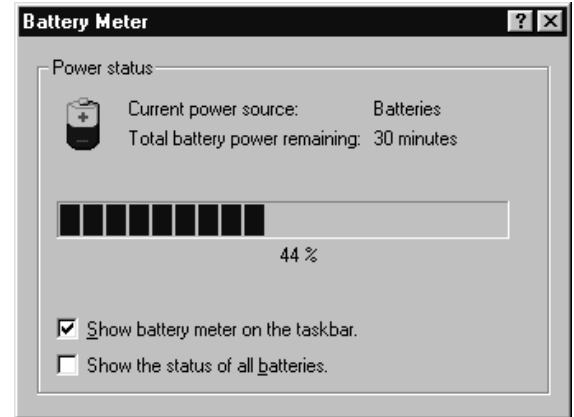

Low-battery warning

Windows displays a low-battery warning when the battery is almost exhausted. The Pedion switches to Disk Suspend mode about three minutes later.



When you see a low-battery warning, you should immediately connect the AC adapter. If the AC adapter is not available, you must shut down the Pedion until it is.

To attach the optional Battery Pack

1. Shut down or suspend the Pedion.
2. Close the LCD panel and turn the system over.
3. Slide open the battery connector cover on the underside of the Pedion (or Multimedia Pack).

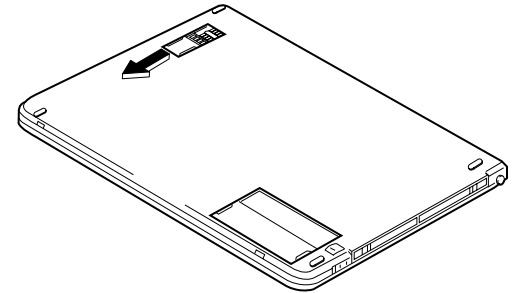

4. Align the two small holes on the rear of the Pedion (or Multimedia Pack) with the two raised catches on the rear edge of the Battery Pack.
5. Slide apart the two latches on the front of the Battery Pack and gently press down on the front edge of the Pedion until it clicks into place. Do not use excessive force.

Caution

Do not open the battery connector cover on the underside of the Pedion or Multimedia Pack unless you intend to install the Battery Pack straight away.

To remove the Battery Pack

1. If the Multimedia Pack is attached, remove any CD or diskette from the drives.
2. Shut down or suspend the Pedion.
3. Close the LCD panel.
4. Slide apart the two latches on the front of the Battery Pack, then lift the Pedion off the Battery Pack.
5. Turn the system over and slide closed the battery connector cover on the underside of the Pedion (or Multimedia Pack).

Recharging the Battery Pack

If the Battery Pack is attached to the Pedion (or Multimedia Pack), it will begin to recharge as soon as you connect the Pedion to the AC power supply. In fact the Battery Pack will recharge first, followed by the Pedion's internal battery.

If the Battery Pack is separated from the Pedion, it can be recharged by connecting the AC adapter to it directly (see diagram).

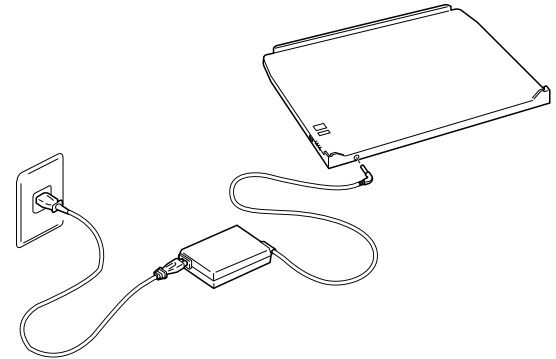

The Battery Pack's Charge Status light  is orange while the pack is recharging, green when it is recharged. The time to recharge depends on the method you use:

- Recharge via Pedion (while working)..... 30 hours
- Recharge via Pedion (while turned off)..... 8 hours
- Recharge directly via AC adapter..... 8 hours

Important

You must not connect the AC adapter to the Battery Pack while the pack is attached to the Pedion or Multimedia Pack.

Checking the battery level (2)

Pressing the Battery Level button on the right-hand side of the Battery Pack illuminates a row of four battery level indicators. The number of indicators lit shows the current battery level: four indicators means 100% charge, three: 75%, two: 50%, one: 25%, and no indicators lit means the pack is discharged.

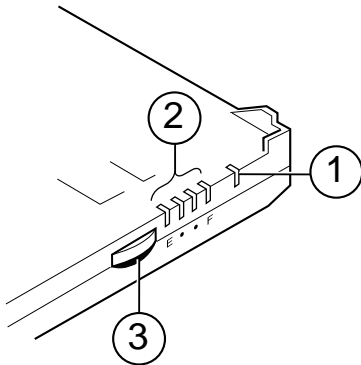

- 1 ① Charge Status light
- 2 Battery level indicator lights
- 3  Battery Level button

If the Battery Pack is attached to the Pedion, you can check the battery level with the Battery Meter, as described earlier in this chapter. If the **Show the status of all batteries** option is ticked, the Battery Meter shows the levels of the internal battery and the Battery Pack separately.

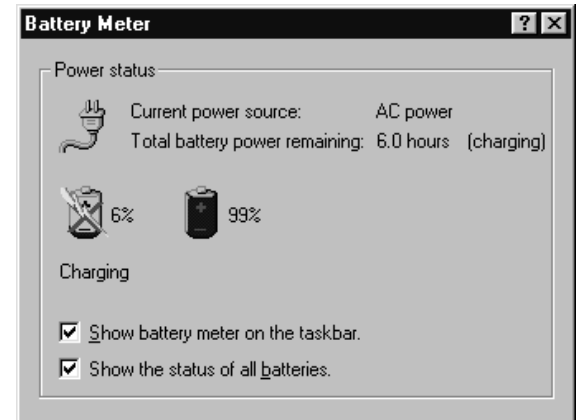

Options for power management

The Pedion has several modes that can be used to conserve power.

The Pedion can also suppress power to components that are idle or unused for longer than a certain interval. This includes the keyboard, touchpad, hard disk, LCD panel, audio system, and peripherals connected to the serial or parallel ports.

Disk Suspend mode

To enter Disk Suspend mode, press the Power button, or choose **Suspend** from the Windows **Start** menu. To resume, press the Power button again.

In this mode, your unsaved work and the Windows environment are first saved onto a special area of the hard disk, then the Pedion is turned off. It takes about 30 seconds to save the system, and 30-50 seconds to restore it.

With BIOS Setup, you can configure the Pedion to enter Disk Suspend mode after a specified period of inactivity.

Memory Suspend mode

To enter Memory Suspend mode, close the LCD panel. To resume, open the LCD panel and press the Power button.

In this mode, your unsaved work and the Windows environment are kept in the Pedion's memory. This mode uses more power than Disk Suspend, but you can resume working in only a few seconds.

"Energy Star" energy-saving features

The Display Properties of the LCD panel can be configured under Windows to suppress or shut off power to the LCD panel after specified periods of inactivity. The Pedion arrives with these features turned off.

Note

As an Energy Star partner, Mitsubishi Electric Corporation has determined that this product meets the international Energy Star program for energy efficiency.

Disk drive low power mode

The Power Properties of the hard disk can be configured under Windows to suppress power after specified periods of inactivity, depending on whether or not the Pedion is running from the AC power supply or its own batteries. The Pedion arrives with these timeouts set to 30 and 3 minutes respectively.

Standby mode

The Pedion can automatically suppress power to idle components, including the LCD panel, after a specified period of inactivity. To restore the system, press any key or use the touchpad.

The Pedion arrives with this feature turned off. If you want to use it, you must set a Standby timeout period with the BIOS Setup utility.

Idle mode

The Pedion can slow its Pentium processor during brief periods when the system is not busy.

The Pedion arrives with this feature turned off. If you want to use it, you must enable it with the BIOS Setup utility.

Hard Disk and Video Timeouts

The Pedion can suppress power to the hard disk and the LCD panel after specified periods of inactivity.

The Pedion arrives with the hard disk inactivity timeout set to 1 minute and the video (LCD) timeout disabled. You can change these settings with the BIOS Setup utility.

Note for Windows NT users

Neither Disk Suspend nor Memory Suspend mode should be attempted with Windows NT.

More about Disk Suspend mode

In Disk Suspend mode your unsaved work and the Windows environment are written to the Pedion's hard disk before the power is turned off. A special area of the hard disk is reserved for this purpose. While in this mode, the Power Status light is unlit.

It can take up to 30 seconds to write the information onto the hard disk. Do not press the Power button during this time or move the Pedion before it has turned itself off.

You can enter Disk Suspend mode manually whenever you want to. With BIOS Setup, you can also configure the Pedion to enter Disk Suspend mode after a specified period of inactivity (the "Auto Suspend timeout").

The Pedion automatically enters Disk Suspend mode three seconds after a low-battery warning.

To enter Disk Suspend mode

1. Press the Power button or choose **Suspend** from the Windows **Start** menu.
2. Wait until the Pedion's Power Status light ① goes out.

Caution

Do not use a disk compression utility such as DriveSpace. It will cause the Disk Suspend operation to fail.

Holding down the Power button for more than three seconds puts the Pedion into an abnormal state. If you press the Power button again, the system will be restarted and any unsaved work will be lost.

Note

The function of the Power button can be changed with the BIOS Setup utility.

Pedion cannot go into Suspend mode while the Infrared Monitor is searching for infrared devices.

Do not use Suspend mode when connected to a network; the system may not resume correctly.

To restore the system from Disk Suspend mode

- ◆ Press the Power button (if there has been a low-battery warning, connect the AC adapter first).

To set up an Auto Suspend timeout

1. Start the Setup utility.
2. Select the **Power Saving** menu.
3. Set **Power Management** to “Customized”.
4. Make sure that **Suspend Mode** is set to “Save To Disk”.
5. Set the **Auto Suspend Timeout** to the desired value.
6. Exit the Setup utility, saving changes.

To change the function of the Power button

Normally, pressing the Pedion's Power button puts the system into Disk Suspend mode. You can change the function of the Power button so that it either turns the Pedion on and off or causes Memory Suspend mode instead.

1. Start the Setup utility.
2. Select the **Power Saving** menu.
3. To make the Power button turn the Pedion on and off, set **Switch Button** to “On/Off”. Otherwise, leave it set to “Sus/Res”.
4. To make the Power button put the Pedion in Memory Suspend mode, set **Suspend Mode** to “Suspend”. For Disk Suspend mode (the default setting), set it to “Save To Disk”.
5. Exit the Setup utility, saving changes.

For more information, refer to the chapter on “BIOS Setup”.

More about Memory Suspend mode

In Memory Suspend mode your unsaved work and the Windows environment are written to the Pedion's memory before the power is suppressed. While in this mode, the Power Status light is orange.

You can enter Memory Suspend mode manually, simply by closing the LCD panel.

Note

The function of the Power button can be changed with the BIOS Setup utility (see previous page).

Pedion cannot go into Suspend mode while the Infrared Monitor is searching for infrared devices.

*If the **Resume On Modem Ring** or **Resume On Time** options are enabled in the BIOS Setup utility, the system can resume automatically, either on serial port activity (not PC Card modem) or at a specified time.*

Do not use Suspend mode when connected to a network; the system may not resume correctly.

To enter Memory Suspend mode

- ◆ Close the LCD panel (without first pressing the Power button).

To restore the system from Memory Suspend mode

- ◆ Press the Power button.

5 CONNECTING OPTIONAL DEVICES

It is possible to connect various optional devices, either directly to the Pedion or to the Multimedia Pack. This chapter provides advice on the types of devices that can be connected, and how to connect them.

Suspend or shut down?

In some cases, you must suspend or shut down the Pedion before connecting an optional device. The procedure for the device in question makes this clear.

- ◆ PC Cards (also called PCMCIA cards)
- ◆ Infrared devices
- ◆ Universal Serial Bus (USB) devices
- ◆ Printer (or some other parallel port device)
- ◆ Serial port device
- ◆ External keyboard or numeric keypad
- ◆ Mouse
- ◆ External colour monitor

Installing a PC Card

There are two PC Card slots on the left side of the Pedion. Each slot can accommodate either a Type I (3.3 mm) or a Type II (5.0 mm) card.

Slot 0 (towards the rear) can accept PC Cards with either CardBus or Zoomed Video (ZV) functions; Slot 1 accepts CardBus only.

- ◆ CardBus is the 32-bit version of PC Card technology. CardBus allows speeds of up to 133 Mbps at 33 MHz.
- ◆ Zoomed Video allows the PC Card to write unbuffered data directly to the Pedion's video controller.

Note for Windows NT users

You must shut down the Pedion before inserting or removing a PC Card when using Windows NT. CardBus and Zoomed Video cards cannot be used with Windows NT 4.0.

To install a PC Card

1. Hold the PC Card with the logo side facing up.
2. Insert the PC Card carefully into the chosen slot.

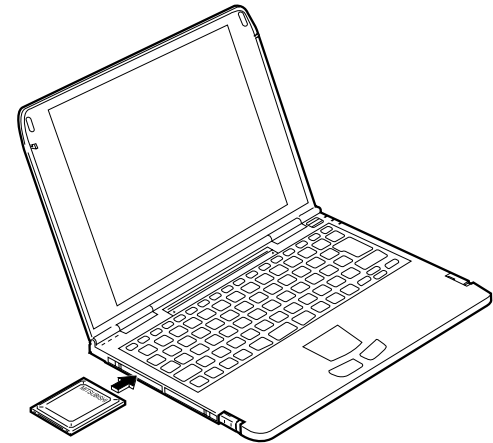

- When the slot's eject button pops out, fold it back into its recess on the side of the Pedion. The two eject buttons fold in different directions.

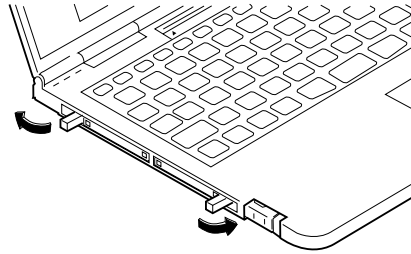

- Connect any necessary cable to the PC Card.

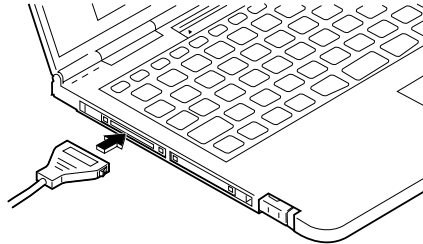

- Configure the PC Card software.

To remove a PC Card

- Follow the procedure for terminating card operations under Windows.
- Fold the slot's eject button out of its recess, then push it firmly.

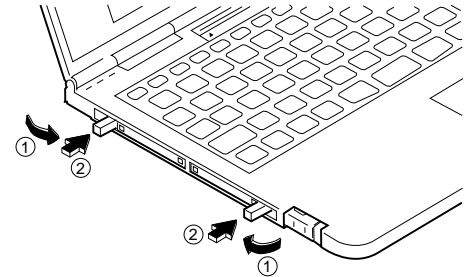

- Pull the PC Card completely out of the slot.

The PC Card may become hot. This is normal and not a problem.

Connecting an infrared device

The Pedion can use the same kind of infrared signal as that used by a TV or video remote control to communicate with another computer or peripheral device. The Pedion supports the IrDA 1.0 and IrDA 1.1 Fast Infrared (FIR) standards promoted by the Infrared Data Association.

When using the infrared port, it is important to ensure that the two devices about 1 metre apart and within an angle of 15 degrees of a clear line-of-sight between the two ports.

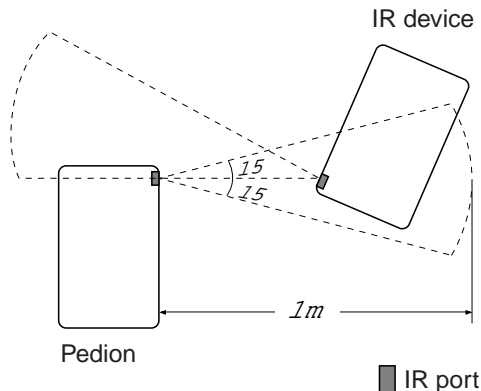

General advice on IR communication

- ◆ Communication is one-to-one only.
- ◆ Communication under a fluorescent lamp may decrease the speed of data transfer.
- ◆ Keep TV or VCR remote controls away from the effective range of the infrared ports.
- ◆ During communication, do not move the two communicating devices.
- ◆ The Pedion is configured at the factory to use the IrDA 1.0 standard. If necessary, you can change this to Fast Infrared with the BIOS Setup utility and the Windows Control Panel.

Infrared Monitor

An Infrared Monitor program is provided to help you keep track of the Pedion's infrared activity. The Infrared Monitor can normally be opened by double-clicking the Infrared icon in the Windows taskbar.



Infrared icon

The default settings of the Infrared Monitor ensure that the Pedion searches for infrared devices within range every 3 seconds. If a suitable device is found, and provided that it is Plug and Play aware, its associated software can be installed automatically and communication can begin.

With the Infrared Monitor, you can:

- ◆ Find out what infrared devices are within range.
- ◆ Find out if the Pedion is currently communicating with an infrared device, and if it is, how well it is communicating.
- ◆ Control how Infrared Monitor reports status on the infrared activity it detects.
- ◆ Decide what type of infrared activity to allow.

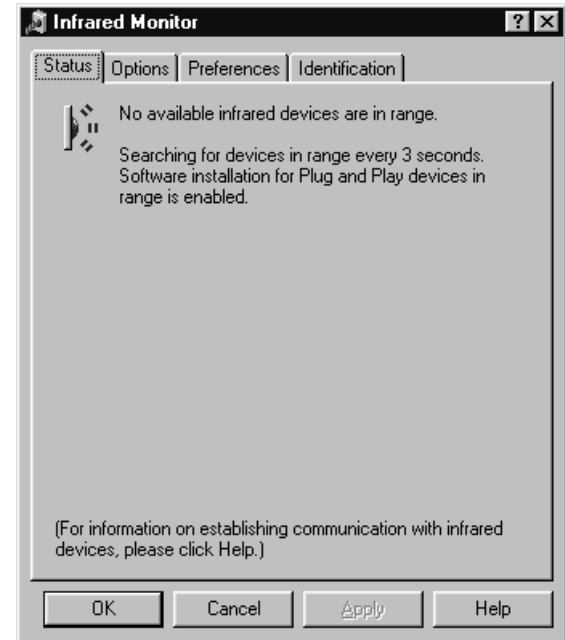

For more information, click the Help button in the Infrared Monitor dialog.

To display the Infrared icon

Follow this procedure if the Infrared icon is not present in the Windows taskbar.

1. Click the **Start** button in the Windows taskbar, point at **Settings** and then click **Control Panel**.
2. Double-click the **Infrared** icon.
3. Click the Preferences tab.
4. Make sure that **Display the infrared icon in the taskbar** is ticked.

To turn off searching

The Pedion cannot go into Suspend mode while the Infrared Monitor is searching for infrared devices.

1. Right-click the Infrared icon in the Windows taskbar.
2. Make sure that **Search for devices in range** is not ticked.

To change to Fast Infrared mode

1. Start the BIOS Setup utility.
2. Select the **Advanced** menu.
3. Select the **I/O Device Configuration** sub-menu.
4. Change the **Mode** option of **Serial Port B** to "FIR".
5. Exit the Setup utility, saving changes.

When Windows restarts, it detects the change in configuration and starts the Update Device Driver wizard.

6. Click **Next** to search for updated drivers, then click **Other Locations**.
7. In the Select Other Locations dialog, type `c:\windows\options\cabs` and then click **OK**.
8. Click **Finish**. (If the Welcome To Windows dialog appears, close it.)
9. Click the **Start** button in the Windows taskbar, point at **Settings** and then click **Control Panel**.
10. Double-click the **Add New Hardware** icon.

11. In the Add New Hardware wizard, click **Next**.
 12. Click **No** in answer to the question “Do you want Windows to search for your new hardware?”, and then click **Next**.
 13. Select the **Infrared** entry in the Hardware Types list, and click **Next**.
 14. In the Add Infrared Device wizard, click **Next**, and then click **Have Disk**. In the Install From Disk dialog, type `c:\windows\options\cabs` and then click **OK**.
 15. Make sure that the Add Infrared Device wizard shows the infrared device model as (FIR) Built-in Infrared port on laptop or desktop, and then click **Next**.
 16. Select **Fast Infrared Communications Port (COM2)**, click **Next** twice, and then click **Finish**.
 17. In the Control Panel, double-click the **Infrared** icon.
 18. On the Identification tab, type a suitable computer name and description, and then click **OK**.
 19. Click **Yes** to restart the Pedion.
- When Windows restarts, follow the procedure given earlier in this chapter to display the Infrared icon in the taskbar.

Connecting a USB device

The Pedion and the Multimedia Pack each have one USB (Universal Serial Bus) port. If the Pedion is docked with the Multimedia Pack, both ports can be used simultaneously.

About the Universal Serial Bus (USB)

The USB is a relatively new way of connecting peripherals to your computer. It has several advantages over existing serial and parallel ports.

- ◆ Several USB devices can be “daisy-chained” together.
- ◆ USB devices are “hot-pluggable”; that is, they can be plugged in and disconnected without turning off the computer.
- ◆ The USB can supply DC power to certain devices, so that they do not need an independent power supply.

USB is also quite fast, operating at 12 megabits per second, which is appropriate for a wide range of applications including video conferencing cameras.

To connect a USB device

Before connecting any USB device, we recommend that you read all documentation provided with the device.

1. If connecting to the Pedion, peel back the rubber cover from the USB port.
2. Plug the USB cable into the USB port on the Pedion or the Multimedia Pack.

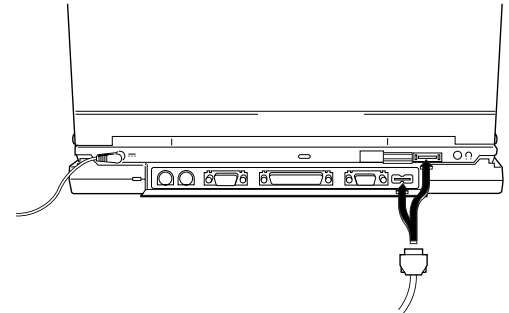

Windows should automatically recognise the USB device.

Connecting a printer (or other parallel port device)

You can connect a printer to the parallel port of the Multimedia Pack.

The Pedion arrives with the parallel port is set to Bi-Directional mode. Extended Capabilities Port (ECP) and Enhanced Parallel Port (EPP) functionality is also supported, and can be configured with the BIOS Setup utility.

- ◆ ECP is good at transferring big blocks of data quickly (e.g. scanners, printers). The parallel port in ECP mode uses a DMA channel.
- ◆ EPP is good for links that switch directions frequently (e.g. drives).

Note

When disconnecting a parallel port device, turn off the printer before shutting down the Pedion.

To connect a printer

1. Shut down the Pedion.
2. Plug the printer cable into the parallel port on the rear of the Multimedia Pack. Tighten both the screws to secure the connection.

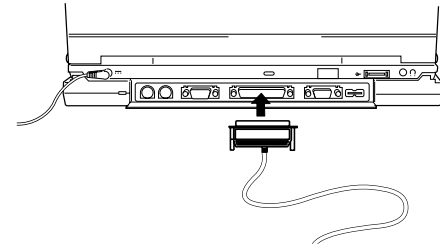

3. Connect the printer cable to the printer as described in the printer's manual.
4. Turn on the printer.
5. Turn on the Pedion.

Connecting a serial port device

You can connect a device such as a modem or barcode scanner to the serial port of the Multimedia Pack.

Note

When disconnecting the serial device, turn off the device before you shut down the Pedion.

To connect a serial device

1. Shut down the Pedion.
2. Plug the serial cable into the serial port on the rear of the Multimedia Pack. Tighten both the screws to secure the connection.

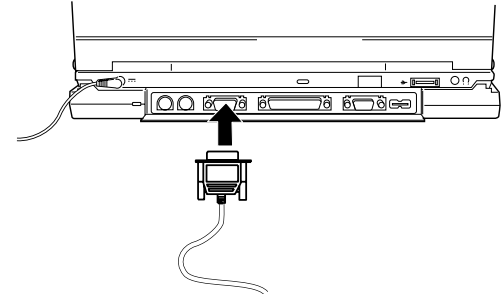

3. Connect the serial cable to the device as described in the device's manual.
4. Turn on the serial device (if applicable).
5. Turn on the Pedion.

Connecting an external keyboard or mouse

To connect a keyboard

1. Shut down the Pedion.
2. Plug the keyboard (or numeric keypad) into the keyboard port on the rear of the Multimedia Pack.

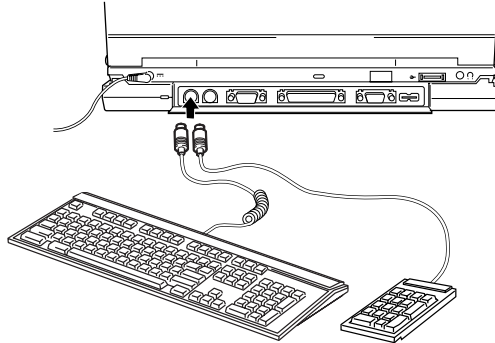

3. Turn on the Pedion.

Note

Before disconnecting a keyboard or mouse, shut down the Pedion.

To connect a mouse

1. Shut down the Pedion.
2. Plug the mouse into the mouse port on the rear of the Multimedia Pack.

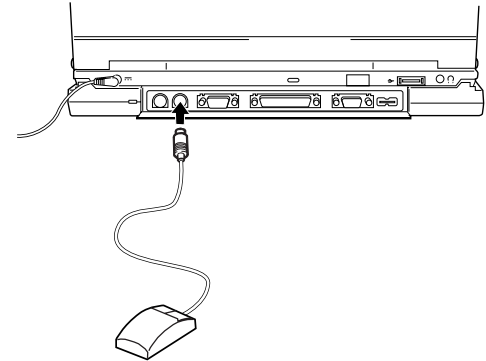

3. Turn on the Pedion.

Note

When a mouse is connected, the touchpad doesn't work.

Connecting an external monitor

You can connect an external colour monitor to the monitor port of the Multimedia Pack.

Note

The screen resolution and refresh rate of the LCD panel must be supported by the external monitor.

When disconnecting the monitor, turn off the monitor before shutting down the Pedion.

To connect a monitor

1. Shut down the Pedion.
2. Plug the monitor's signal cable into the monitor port on the rear of the Multimedia Pack.

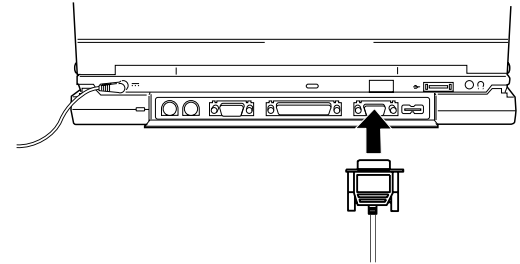

3. Tighten both the screws to secure the connection. Turn on the monitor.
4. Turn on the Pedion.
5. Click **Start**, point at **Settings**, then click **Control Panel**.
6. Double-click the **Display** icon to open the Display Properties dialog.

7. Click the NeoMagic tab.
8. Click **Display Options**.
9. Select **Monitor**, **LCD Panel** or **Monitor/LCD** according to whether you want to display Windows on the external monitor, the LCD panel, or both at the same time.

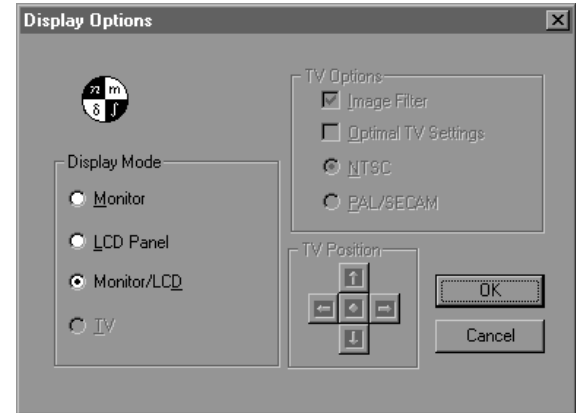

6 BIOS SETUP

Using the Setup utility

The BIOS (Basic Input/Output System) mediates between the computer's hardware – the processor, memory, and so on – and its software – the operating system and your programs. The BIOS program is kept in permanent, read-only memory or ROM.

Setup is a helpful utility that forms part of the BIOS program. It allows you to view and alter the computer's hardware configuration. Configuring the computer may be necessary to ensure that the software you use can recognise and exploit the hardware's capabilities.

The current configuration is kept in a special area of memory, called CMOS memory, and maintained by a battery so that the configuration is preserved even while the computer is switched off.

Your computer arrives already configured, but may need to be configured again in certain circumstances.

Whenever the computer is turned on, the BIOS power-on self-test (POST) routine tests various hardware components, including memory, and compares the actual configuration of the computer with that recorded in permanent (CMOS) memory.

Using the Setup utility is fairly straightforward; all of the options and control keys available are constantly displayed at the bottom of the screen, and there is item-specific help displayed on the right of the screen for whichever item is currently selected.

The Setup utility contains the following main menu screens:

- ◆ Main
- ◆ Advanced
- ◆ Security
- ◆ Power Saving
- ◆ Exit

There are many parameters which can be changed in the Setup utility. These can easily be reviewed by browsing through the Setup utility itself, and are therefore not covered in detail here.

Getting help in Setup

You can get general help about the control keys at any time by pressing the F1 key.

The Help window on the right-hand side of each screen displays help text for the currently-selected field. It changes as you move the cursor from one field to another.

To start the Setup utility

1. Turn on or restart the Pedion.
2. Wait until the "Pedion Mobile Computer" logo appears on the screen.
3. Press the F2 key.
4. If you have previously defined a Supervisor password, you are prompted for it before Setup starts.

If Setup starts on its own

Setup might start on its own for the following reasons:

- ◆ The power-on self-test (POST) detects a configuration error or fault. This may be signalled by one or more POST error messages. If a persistent fault is indicated, make a note of any error messages and the current Setup configuration settings before calling an authorised maintainer.
- ◆ The CMOS battery may be running down. This may cause spurious POST error messages. If this happens every time you turn on the computer, you may have to change the battery. Contact your Mitsubishi Electric PC supplier or maintainer to have the CMOS battery renewed.

Press	To
F1 or Alt-H	View a general help topic. Press Esc to close the help window.
Esc	Exit the current menu.
Left or Right arrow	Select a different menu.
Up or Down arrow	Select fields on the current menu.
Plus (+) or F6 or Spacebar	Select the next value for the current field.
Minus (-) or F5	Select the previous value for the current field.
Enter	Execute a command or enter a sub-menu.
Home or End	Move the cursor to the top or bottom of the current menu.
PgUp or PgDn	Move the cursor to the next or previous page of the current menu.
F9	Restore the default settings for all menus (this does not restore the original factory settings).
F10	Save any changes you've made and exit Setup.

Control keys

Use the keys listed in the legend bar at the bottom of the Setup screen to make your selections or exit the current menu.

Sub-menus are marked by a triangular pointer. To display a sub-menu, use the arrow keys to move the cursor to the sub-menu you want, then press Enter.

Changeable fields are enclosed in square brackets. To select an item, use the arrow keys to move the cursor to the field you want. Then use the Plus (+) and Minus (-) keys to select a value for that field.

Caution

*The default BIOS settings are not necessarily the same as the original factory settings, and therefore may not be appropriate for your particular system. Make a note of the current settings before pressing F9 or using the **Load Setup Defaults** command of the **Exit** menu.*

Saving changes and exiting Setup

To save changes, without exiting Setup

1. Press Esc to make the Exit screen appear.
2. Select the **Save Changes** option and press the Enter key. The Setup Confirmation dialog appears.
3. Press Spacebar to select **Yes**, then press Enter.

To exit Setup, saving changes

1. Press Esc to make the Exit screen appear.
2. Select the **Exit Saving Changes** option and press the Enter key. The Setup Confirmation dialog appears.
3. Press Spacebar to select **Yes**, then press Enter.

To exit Setup, without saving changes

1. Press Esc to make the Exit screen appear.
2. Select the **Exit Discarding Changes** option and press the Enter key. The Setup Warning dialog appears.
3. Press Spacebar to select **No**, then press Enter.

The most useful options within Setup

Advanced, I/O Device Configuration

Use the options in this sub-menu to configure the serial, infrared and parallel ports.

The IR port (Serial Port B) is initially set to IrDA 1.0 mode; if necessary, you can change this to IrDA 1.1 Fast Infrared (FIR) mode, which requires DMA1 or DMA3.

The parallel port is initially set to Bi-Directional mode; you can change this to Extended Capabilities Port or Enhanced Parallel Port mode (ECP requires DMA1, DMA2 or DMA3). The parallel port can be disabled to save power.

DMA requirements mean that the Pedion cannot use the diskette drive and the FIR, ECP and audio features at the same time. If necessary, you can disable the diskette drive to free DMA2. The audio system requires DMA0 and DMA1 and cannot be disabled.

Power Saving

You can use these options to configure the Pedion's power saving modes and features, although the factory settings will serve for most situations. You can redefine the action of the Power button, and set automatic timeouts for Disk Suspend and Standby modes, and hard disk and video activity.

Security

You can use these options to define a Supervisor password that is required every time you start the Setup utility. Optionally, the password can also be required every time you start the Pedion.

To set a Supervisor password

1. Start the Setup utility.
2. Select the **Security** menu.
3. Select **Set Supervisor Password** then press Enter.

4. In the Set Supervisor Password dialog, type the password, press Enter, type it again for confirmation, then press Enter again.
5. Press Enter to save the password and continue.
6. If you want the password to be requested every time you start the Pedion, set **Password on boot** to "Enabled".
7. Exit from Setup, saving changes.

You can use this procedure to change the password, except that you will have to type the old password before you type the new password (or press Enter, if you want to delete the old password).

Once you define a Supervisor password, you can also define a User password. This works like the Supervisor password except that certain critical options in the Setup utility are not available.

If a password is typed incorrectly three times in a row, the message SYSTEM DISABLED is displayed and the system halts. In this situation, you must insert a non-metallic probe into the Emergency OFF hole to turn off the Pedion, then press the Power button to turn it on again.

If you forget the password, contact your Mitsubishi Electric PC supplier or authorised maintainer.

7 TROUBLESHOOTING

This chapter offers advice if you suspect a fault with your computer. It is concerned mainly with problems caused by the computer itself; problems more often arise from other sources such as your operating system or application software.

If you are apprehensive

Make a note of any of the symptoms, error codes, displayed messages and so on, then turn off the computer and unplug all power cords before consulting your supplier or maintenance provider.

If something goes wrong ...

- ◆ Read this chapter.
- ◆ Review the rest of this manual to make sure you are operating the computer correctly.
- ◆ Read the **Important Apricot User Information** help file located on the Windows desktop.
- ◆ Consult your Mitsubishi Electric PC supplier or authorised maintainer.

Pedion

Problem	Possible solutions
Cannot turn system on	<ul style="list-style-type: none"> ◆ If using the internal battery, it may need to be charged. ◆ If using the AC adapter, check that it is connected properly and that the power supply is turned on at the AC outlet.
Hot keys fail to work	<ul style="list-style-type: none"> ◆ The computer may simply be busy. Wait until all hard disk activity or data transfer has ceased, then try again.

Diskette Drive (FDD)

Problem	Possible solutions
Drive does not work	<ul style="list-style-type: none"> ◆ Check that diskette is properly inserted. ◆ Check that diskette is properly formatted. ◆ Check that the Pedion is properly connected to the Multimedia Pack. ◆ Use BIOS Setup to check that the diskette controller is enabled and that there are no security settings which prevent access to the drive.
Diskette cannot be read	<ul style="list-style-type: none"> ◆ If the system has recently been subject to extreme or rapidly changing temperatures, allow at least one hour for the system to reach the new ambient temperature and for any condensation to evaporate.

Hard Disk Drive (HDD)

Problem	Possible solutions
System does not boot from disk	<ul style="list-style-type: none"> ◆ Use BIOS Setup to check that the hard disk drive (primary master) is defined correctly and that the boot options are also correct. ◆ Certain Windows system files may have become corrupted. Use the emergency startup diskette mentioned in the “Welcome” chapter. ◆ Make sure that the diskette drive does not have a diskette in it.
Windows does not start correctly from the hard disk	<ul style="list-style-type: none"> ◆ Restart Windows in Safe Mode by pressing F8 at the Starting Windows prompt.
Disk contents cannot be read	<ul style="list-style-type: none"> ◆ If the system has recently been subject to extreme or rapidly changing temperatures, allow at least one hour for the system to reach the new ambient temperature and for any condensation to evaporate.

CD-ROM

Problem	Possible solutions
Drive does not work or CD cannot be read	<ul style="list-style-type: none"> ◆ Check that the CD is inserted correctly. ◆ Check that the CD is free from fingerprints and dust. ◆ Check that the Pedion is properly connected to the Multimedia Pack.

Internal battery or Battery Pack

Problem	Possible solutions
<p>Battery will not fully charge, or battery life is very short</p>	<ul style="list-style-type: none"> ◆ Make sure you are charging the battery correctly. Refer to the chapter on “Battery and Power Management”. ◆ The battery may be exhausted and need replacing. Contact your Mitsubishi Electric PC supplier or maintainer.

LCD panel

Problem	Possible solutions
<p>Screen appears blank</p>	<ul style="list-style-type: none"> ◆ The Pedion may be in a power-saving mode, as discussed in the chapter on “Battery and Power Management”. Try pressing any keyboard key or the Power button. ◆ If an external monitor is attached, Windows’ Display Properties may be configured to use that rather than the LCD, as described in the chapter on “Connecting Optional Devices”.

Serial port device

Problem	Possible solutions
Serial device does not work	<ul style="list-style-type: none"> ◆ Check that the serial device is turned on. ◆ Check the cable connection. ◆ Check that the Pedion is properly connected to the Multimedia Pack. ◆ Use BIOS Setup to check that the serial port is enabled. ◆ Use BIOS Setup and the Windows Control Panel to check that there are no resource conflicts with PC Cards.

PC Cards

Problem	Possible solutions
PC card does not work	<ul style="list-style-type: none"> ◆ Check that the card is inserted properly. ◆ If the PC card requires an external cable e.g. for connection to the telephone network, check that this is connected correctly. Refer to the documentation that came with the PC Card. ◆ Check that the PC Card device driver software is properly installed. Again, refer to the relevant documentation.

Problem	Possible solutions
PC Card stops working after Pedion has been suspended	<ul style="list-style-type: none">◆ Suspend mode should not be used with communication PC Cards, as it affects the remote connection. If a Suspend mode has been activated, this may cause a PC Card to operate incorrectly. Restart the computer and use BIOS Setup to make sure that a Suspend mode cannot be entered automatically.

External keyboard, numeric keypad or mouse

Problem	Possible solutions
External device does not work	<ul style="list-style-type: none">◆ Check that the device is properly connected. Refer to the chapter on “Connecting Optional Devices”.◆ Check that the Pedion is properly connected to the Multimedia Pack.◆ If using a mouse, remove the ball from inside the mouse, and clean it.

Printer

Problem	Possible solutions
Printer does not print	<ul style="list-style-type: none"> ◆ Check the printer cables and connections. ◆ Make sure the printer was turned on before turning on the Pedion. ◆ Check that the Pedion is properly connected to the Multimedia Pack. ◆ Use BIOS Setup to make sure the parallel port is configured correctly for the type of printer; e.g. some printers require ECP mode. ◆ Check that the printer driver software is properly installed. Refer to the documentation that came with your printer.

Touchpad

Problem	Possible solutions
Touchpad does not work at all	<ul style="list-style-type: none"> ◆ If an external mouse is connected, the touchpad is automatically disabled. ◆ Make sure there is nothing metallic on or near the touchpad.
Touchpad responds slowly	<ul style="list-style-type: none"> ◆ Make sure both the touchpad and your finger are clean and dry.

External monitor

Problem	Possible solutions
Nothing appears on the external monitor	<ul style="list-style-type: none"> ◆ Check that the monitor cable is properly connected. Check that the display is turned on. ◆ Check that the Pedion is not in a power-saving mode. ◆ Make sure the monitor's brightness and contrast controls are adjusted properly. ◆ Check that the Pedion is properly connected to the Multimedia Pack. ◆ Use the Display Properties dialog in the Windows Control Panel to ensure that the display appears on the external monitor. See the chapter on "Connecting Optional Devices".
Cannot switch from the LCD panel to the external monitor	<ul style="list-style-type: none"> ◆ Check that the external monitor can support the resolution and refresh rate of the LCD panel. These can be adjusted in the Display Properties dialog in the Windows Control Panel.
The display is skewed or distorted	<ul style="list-style-type: none"> ◆ Adjust the monitor's display dimensions, position or pincushion distortion according manual that came with the monitor.

Infrared communication

Problem	Possible solutions
The infrared feature does not work	<ul style="list-style-type: none"> ◆ Make sure the surface of the infrared port is clean. ◆ Make sure there is a clear line-of-sight between the Pedion and the infrared device and that there is nothing obstructing the infrared beam. ◆ Check the settings in the Infrared Monitor in the Windows Control Panel. ◆ Use BIOS Setup to make sure that the infrared port is enabled.
Erroneous data is transmitted or received	<ul style="list-style-type: none"> ◆ Make sure that the Pedion and the infrared device are no more than one metre apart. ◆ Make sure that bright artificial light or sunlight is not interfering with the infrared beam. ◆ Make sure that other domestic TV or VCR remote controls are not operating near the Pedion. ◆ Use BIOS Setup to make sure that the infrared port is using the correct communication standard.

Microphones, headphones and audio

Problem	Possible solutions
No sound comes from the Pedion's audio output speaker or internal speaker	<ul style="list-style-type: none"> ◆ When the Pedion is docked with the Multimedia Pack, these things are disabled.
No sound comes from the Multimedia Pack's stereo speakers	<ul style="list-style-type: none"> ◆ Adjust the Windows Volume Control (double-click the Loudspeaker icon in the Windows taskbar). ◆ Check that there are no headphones plugged into the Multimedia Pack's audio output jack, as this automatically disables the speakers.
The record audio facility does not work properly	<ul style="list-style-type: none"> ◆ If you are using an external microphone or audio source, make sure that it is properly connected, and switched on. An external microphone must be self-powered.

USB device

Problem	Possible solutions
A USB device does not work	<ul style="list-style-type: none"> ◆ Make sure the USB cable is connected properly. ◆ Make sure the device is turned on. ◆ Check that the Pedion is properly connected to the Multimedia Pack.

A APPENDIX

I/O Address map

You can change the settings used by the serial, parallel and infrared ports with the BIOS Setup utility.

Address	Device
000 - 00F	DMA controller 1
020 - 021	Interrupt controller 1
040 - 043	System timer
060	Keyboard
061	System speaker
064	Keyboard
070 - 071	Real time clock
081 - 08F	DMA page register
0A0 - 0A1	Interrupt controller 2
0C0 - 0DF	DMA controller 2
0F0 - 0FF	Numeric data processor
170 - 177	CD-ROM select

OWNER'S HANDBOOK

Address	Device
1F0 – 1F7	Hard disk select
201	Joystick
220 – 22F	Audio (default)
274 – 277	ISA Plug & Play
2F8 – 2FF	Infrared port (COM2)
330 – 331	MPU-401 port
376	CD-ROM select
378 – 37F	Parallel port
388 – 38B	FM synthesizer
3B0 – 3BB	Video subsystem
3C0 – 3DF	Video subsystem
3F0 – 3F5, 3F7	Diskette drive controller
3F6	Hard disk select
3F8 – 3FF	Serial port (COM1)
CF8 – CFF	PCI configuration register

IRQ table

You can change the interrupt used by the serial, parallel and infrared ports with the BIOS Setup utility.

Priority	IRQ	Cause of interrupt
1	SMI	Power management unit
2	NMI	Parity error, I/O channel error
3	IRQ0	Timer, Counter 0 output
4	IRQ1	Keyboard
	IRQ2	Cascade connection from interrupt controller 2
5	IRQ8	Real time clock
6	IRQ9	CardBus controller, PCI-to-USB Universal Host Controller and NeoMagic MagicGraph 128XD
7	IRQ10	<i>Reserved</i>
8	IRQ11	<i>Reserved</i>
9	IRQ12	Mouse
10	IRQ13	Co-processor
11	IRQ14	Hard disk controller
12	IRQ15	CD-ROM drive controller
13	IRQ3	Infrared port @ 2F8h (factory default)

Priority	IRQ	Cause of interrupt
14	IRQ4	Serial port @ 3F8h (factory default)
15	IRQ5	Audio (factory default)
16	IRQ6	Diskette drive controller
17	IRQ7	Parallel port @ 378h (factory default)

DMA channels

The parallel port in ECP mode requires either DMA1, DMA2 or DMA3. The infrared port in IrDA 1.1 Fast Infrared (FIR) mode requires either DMA1 or DMA3.

DMA requirements mean that the Pedion cannot use the diskette drive and the FIR, ECP and audio features at the same time. If necessary, you can use the BIOS Setup utility to disable the diskette drive and free DMA2. The audio system requires DMA1 and DMA3 and cannot be disabled.

Channel	Function
1	Audio
2	Diskette drive
3	Audio
4	DMA controller

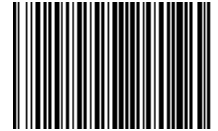

16444731



MITSUBISHI ELECTRIC

PC DIVISION

Apricot Computers Limited
3500 Parkside
Birmingham Business Park
Birmingham B37 7YS
United Kingdom

Tel +44 (0) 121 717 7171

Fax +44 (0) 121 717 7799

MITSUBISHI ELECTRIC

PC DIVISION

Apricot Computers Limited
Niederlassung Deutschland
Gothaer Strasse 27
40880 Ratingen
Germany

Tel +49 (0) 2102 4556

Fax +49 (0) 2102 455700

<http://www.mitsubishi-computers.com>
